

# INSTALLATION & CONFIGURATION MANUAL

## eleon S1 CONTROLLER: Otis RCB II



# table of contents

- About ..... 3
- Package contents..... 3
- Requirements and referred documents ..... 3
- Firmware update..... 4
- Procedure for installation..... 5
  - Schema ..... 5
  - 1. Wiring ..... 6
  - 2. Configuration .....10
  - 3. Troubleshooting .....13
    - 3.1. Blinking LED 1st boot.....13
    - 3.2. Troubleshooting after reloading website .....13
    - 3.3. Check signal strength.....14
    - 3.4. Failed controller connection test .....15
- Contact..... 17

# About

The **eleon S1** is a universal gateway for connecting elevators for monitoring, remote monitoring and maintenance purposes. It is compatible with a wide range of elevator control systems and provides operation- and maintenance-relevant information to elevator companies via an MQTT interface. The following document contains descriptions, explanations and graphics and serves as a guide for the installation and commissioning of the **eleon S1** gateways for the respective elevator control system.

## Package contents

- **eleon S1** – universal elevator gateway
- **eleon C1** – connector box
- antenna
- D-Sub9 cable
- RJ45 patch cable
- CAN / power connector
- Velcro mounting set

## Requirements and referred documents

- The eleon products must only be used, installed, operated, unmounted and configured by **trained and authorized specialists** in electrical engineering and elevator technology.
- Before performing any work on the controller, ensure that the **power is switched off** and ensure a de-energized state for the duration of the work.
- The responsible technician needs to read the **package leaflet**.
- The responsible technician needs to read the **controller identification manual** to identify the controller type and choose the installation and configuration manual accordingly. (provided on **eleon.elfin.de**).
- Only original components (cables, adapters, connectors, etc.) supplied and/or approved by ELFIN Technology GmbH may be used for installation.

- In order to safely install the **eleon S1**, use wires with a cross-section of 0.25 mm<sup>2</sup> to 0.75 mm<sup>2</sup> (AWG23-18) for the connection of the power supply.

## Firmware update

There are two options to update the firmware of the **eleon S1** gateway. You can either update the firmware before commissioning and without a direct connection to the elevator controller, or you can update the firmware during the onboarding process or by requesting an update at the installation site.

- Option 1: Firmware update via hardware switch before installation and without a direct connection to controller  
*see Option 1 Switch Update / OTA Factory Reset at [eleon.elfin.de](http://eleon.elfin.de)*
- Option 2: Firmware update during the onboarding process or by requesting at the installation site

If an update is available, the **eleon S1** downloads it automatically. This process will take about 1 hour.

# Procedure for installation

## Schema

### Machine Room

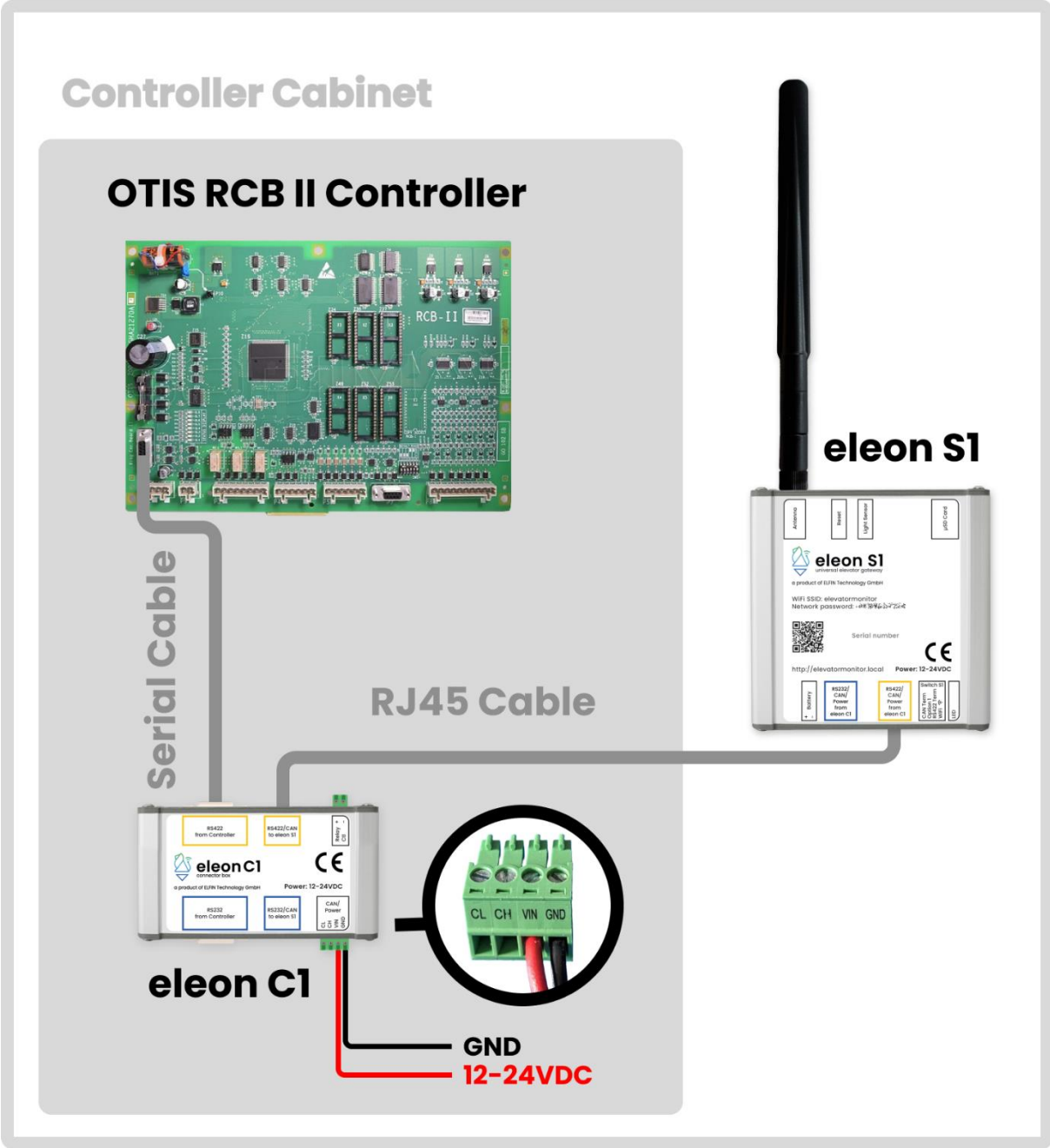

## 1. Wiring

1. Locate a 12-24V DC (200mA at 24V) power source inside the machinery to power the gateway.
2. For safety reasons, turn off the power supply completely.
3. Connect Power and GND to the 24V power supply.
4. Route the cables as clean as possible to the estimated position of **eleon C1**.



5. Connect the power cable to **eleon C1** by using the green plug. Vin: 12-24 VDC GND: to the ground
6. Connect **eleon C1** with **eleon S1** by using the RJ45 patch cable and the orange labelled connector (RS422):



7. Attach the antenna to the **eleon S1**.



8. Locate the D-Sub9 connector on the motherboard.

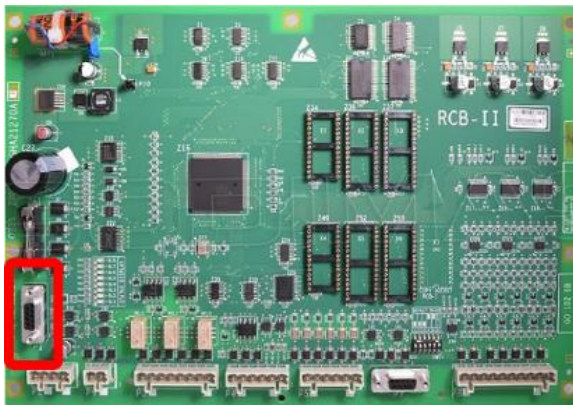

- Use the D-Sub9 cable to connect the controller and **eleon C1** via orange labelled connector (RS422).

## Machine Room

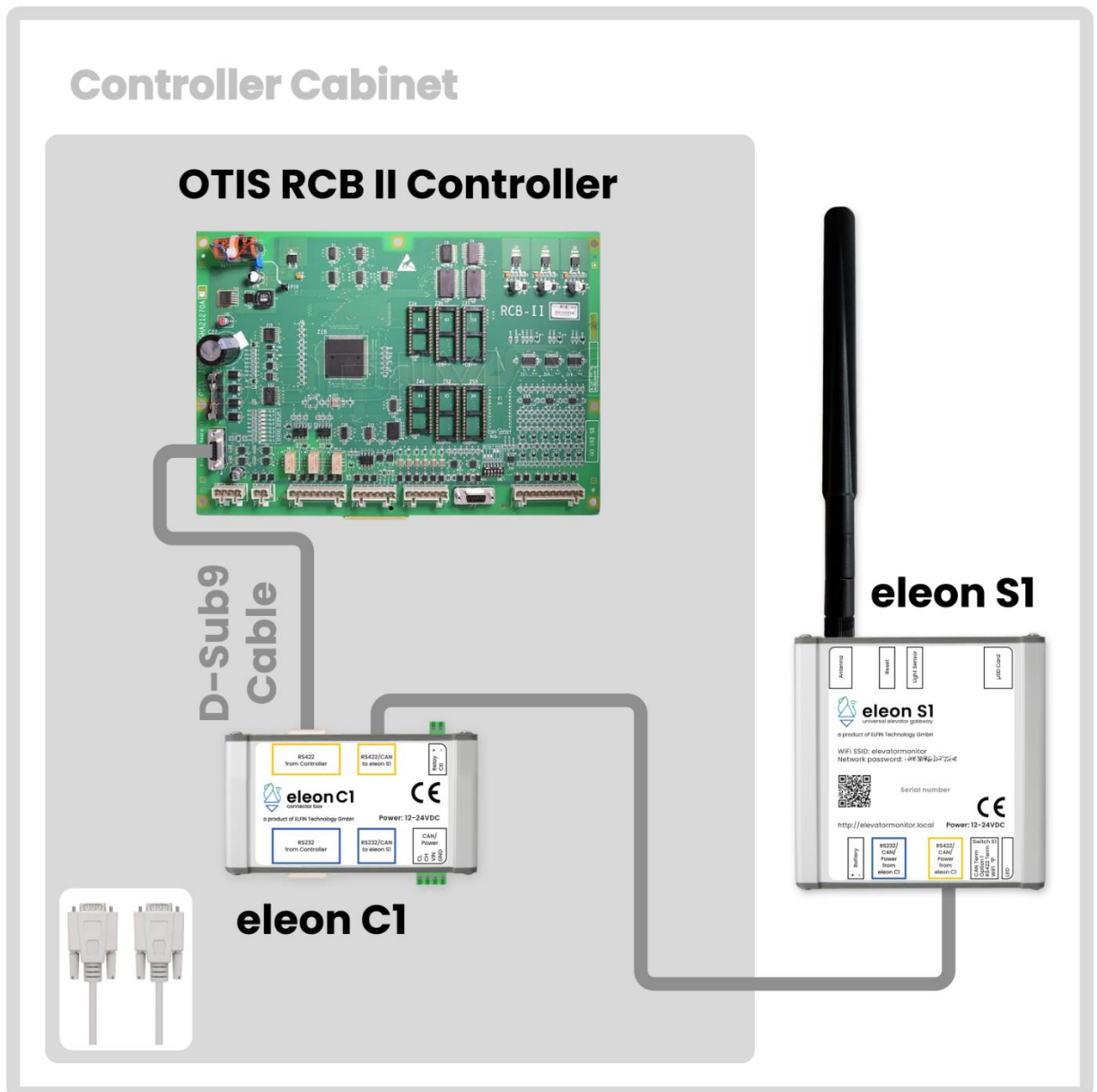

- Turn on the power of the controller and **eleon S1** will start automatically.

## 11. Check green LED on the bottom of **eleon S1**.

→ 1x per second blinking:

normal operation.  
Proceed with the next step.

→ off or irregular blinking:

not operational:  
see *chapter 3:*  
*Troubleshooting section 1*

→ Fast blinking  
(4x per second):

modem is scanning for  
networks.  
Proceed with the next step.



## 2. Configuration

1. When **eleon S1** is wired and powered, WiFi is activated and will turn off automatically after 30 minutes. If you can't find WiFi network, please toggle switch 4. Any position change of the switch will activate the WiFi for 30 min. Afterwards it will automatically turn off.



2. Connect to WiFi.  
→ WiFi SSID: **elevatormonitor**  
→ Password: see **eleon S1**

3. Visit the local website.



→ IOS and Android 12 use <http://elevatormonitor.local> or scan the QRcode

→ For Android devices prior to version 12, please type in the IP address as follows 192.168.4.1 in the browser.

4. Access the website using Onboarding PIN (see package leaflet).

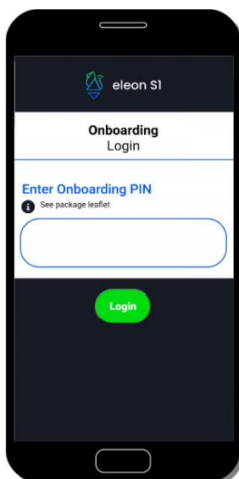

5. Check signal strength.

→ 8 or above 8:

Proceed with the installation. Select Controller and click "Save".

→ Below 8:

Change the tilt of the antenna (0°, -45°, -90°, +45°, +90°). Adjusting the antenna tilt should show changes within 5 seconds.

→ Still below 8:

Change the position of **eleon S1**.

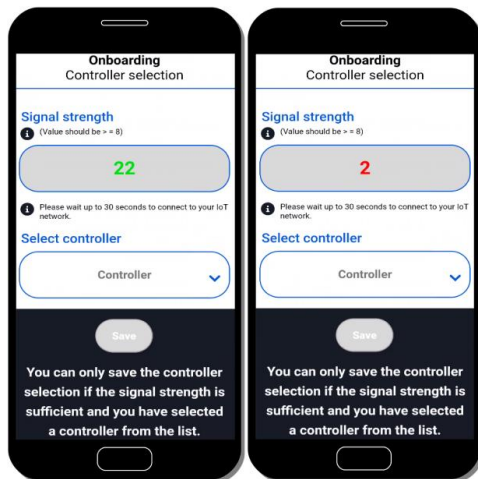

6. If signal strength is sufficient, use two stripes of the velcro mounting set to mount **eleon S1** in its final position and make sure that the signal strength is still sufficient.
7. Choose the **OTIS-RCB2** controller from the dropdown menu on the website.
8. Click on "Save". The **eleon S1** will now restart and the website for Onboarding will be updated.

*In case of issues please see chapter 3: Troubleshooting section 2.*

9. Check if the connection to WiFi "elevatormonitor" is active. *If not, please connect to WiFi using the SSID and PW (printed on **eleon S1**). Enter the onboarding website by using the QR-Code on **eleon S1**, the URL <http://elevatormonitor.local> or 192.168.4.1. In the loaded login screen enter the Onboarding Pin (see package leaflet).*

10. Check signal strength (see above in section 5 for pictures and details).

11. **eleon S1** performs a controller connection test and the website shows if the controller connection was successful or not.

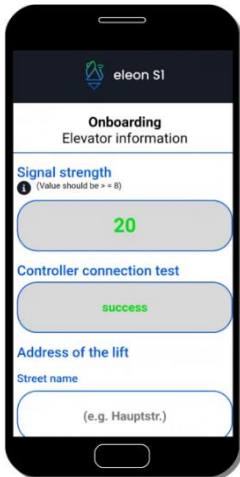

*In case controller connection has failed: see chapter 3: Troubleshooting – section 4.*

12. Arrange the final position for the D-Sub9 cable, power cable and **eleon C1**.

13. Use one stripe from the velcro mounting set to mount **eleon C1** to its final position.

14. Enter specific elevator information on the website and click "Save". Now the device is connecting to the cloud. Wait for the website to give feedback.

15. Make a car call and check if the system is receiving data.

16. Congratulations! Installation is done. You can now set up the device in your portal and check if data is received.

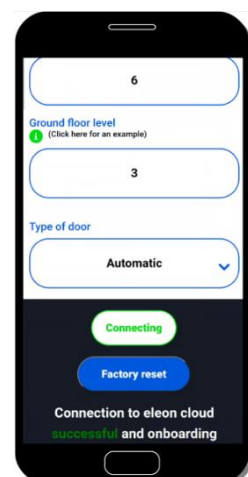

### 3. Troubleshooting

#### 3.1. Blinking LED 1st boot



##### → 1x per second blinking

Normal operation.  
Continue with the installation.

##### → Off:

not operational.

- Check the power supply connection (make sure that there is enough power available - "min. 200mA at 24 V").

##### → Irregular blinking:

not operational.

- Check the power supply connection (make sure that there is enough power available - min. 200mA at 24 V)
- Check for reversed polarity, wiring short circuits, or broken wires.
- Check for suspicious noises in **eleon C1** or **eleon S1**.

##### → Fast blinking (4x per second):

Modem is scanning for networks.  
Continue with the installation.

#### 3.2. Troubleshooting after reloading website



In case the Website does not update automatically: Check if the connection to WiFi "elevatormonitor" is active. If not, please connect to WiFi using the SSID and WiFi PW (see **eleon S1**). A login to the Website might be required again by using Onboarding PIN (see package leaflet).

If the website still does not update, please check the blinking pattern of the green LED:

→ 1x per second blinking:

Normal operation. Continue with the installation.

→ Off:

- not operational.
- Check power connection (verify if sufficient power is provided "200mA at 24V").
  - Check for reversed polarity, wiring short circuits, or broken wires.
  - Check for suspicious noises in **eleon C1** or **eleon S1**.

→ Irregular blinking:

- not operational.
- Check for reversed polarity, wiring short circuits, or broken wires.

→ Fast blinking (4x per second):

- Modem connection problems.
- Proceed with diagnostics on local website [elevatormonitor.local](http://elevatormonitor.local)

### 3.3. Check signal strength

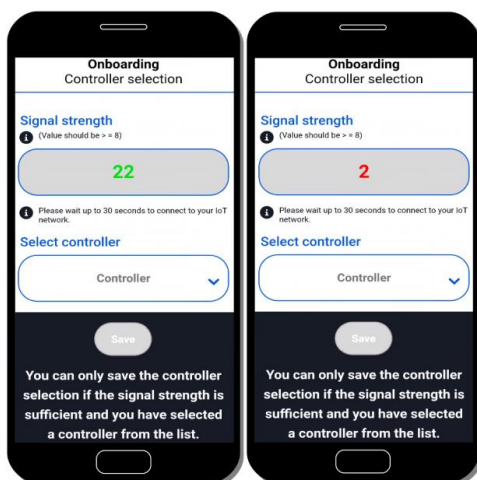

→ 8 or above 8:

Proceed with the installation.  
Select Controller and click  
"Save"

→ Below 8:

Change the tilt of the  
antenna (0°, - 45°, -90°,  
+45°, +90°).  
Adjusting the antenna tilt  
should show changes  
within 5 seconds.

→ Still below 8:

Change the position  
of **eleon S1**.

### 3.4. Failed controller connection test

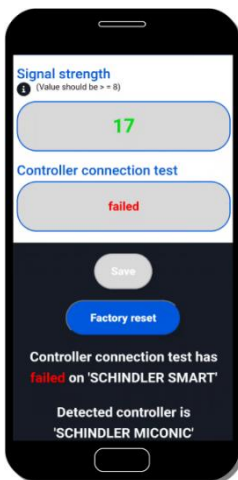

#### 3.4.1. Check if the right controller is selected for the right controller.

If the wrong controller is selected, follow these steps to fix the problem:

- Delete the wrong configuration by clicking "Reset" on the website to make the **eleon S1** reboot.
- Check the WiFi connection and (if necessary) log in to the website.
- For accessing the website, use Onboarding PIN (see package leaflet).
- Make the controller selection suitable to your controller and click "Save".
- Follow instruction from *chapter 2 - section 9*.
- This troubleshooting process can be repeated until the correct controller is chosen.

If you are sure, you have selected the right controller, but the controller connection test still fails, please continue as follows:

3.4.2. Ensure that only cables supplied by ELFIN Technology GmbH are used.

3.4.3. Check the wiring of the D-Sub9-cable to controller and **eleon C1**.

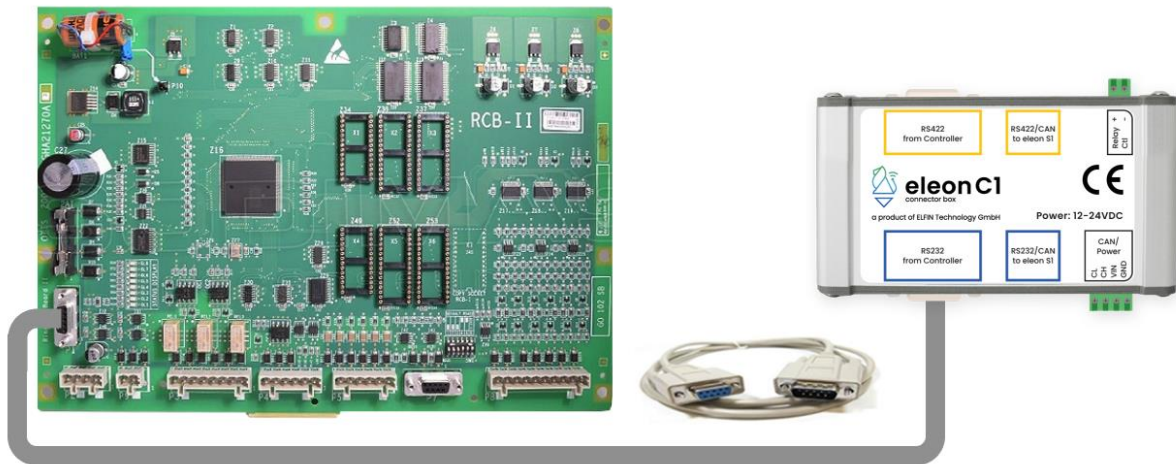

3.4.4. Check the functionality of the D-Sub9 port of the controller and reconnect the controller and the **eleon C1**. Please press the reset button on the **eleon S1**. The restart of **eleon S1** will trigger another controller connection test.



# Contact

Even an extensive documentation cannot answer every question. Do you still have questions or suggestions concerning our **eleon S1** universal elevator gateway?

Please have the following information ready for our customer support:

- customer name
- adress of installation site
- **eleon S1** serial number
- controller type
- if applicable, photo of the controller
- shown signal strength

We look forward to your requests! Please don't hesitate to contact us at:

## ELFIN Technology GmbH

Im Zollhafen 22

50678 Cologne

Germany

Phone: +49 (221) 6778932-0

FAX: +49 (221) 6778932-2

service@elfin.de

www.elfin.de



## Support eleon S1

eleon.elfin.de

Phone: Phone: +49 (221) 6430816-3

support@elfin.de

